



TRB142



HARDWARE

FRONT VIEW

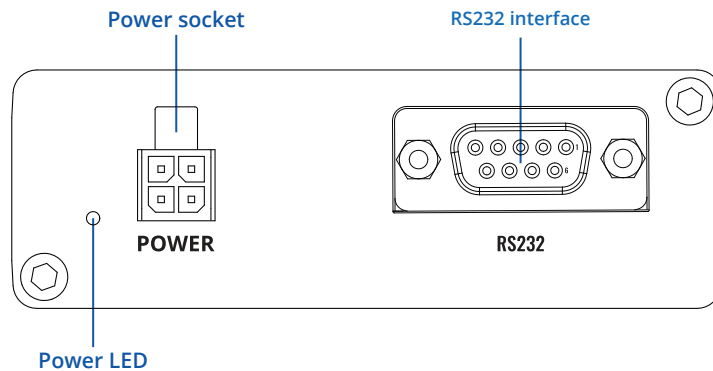

BACK VIEW

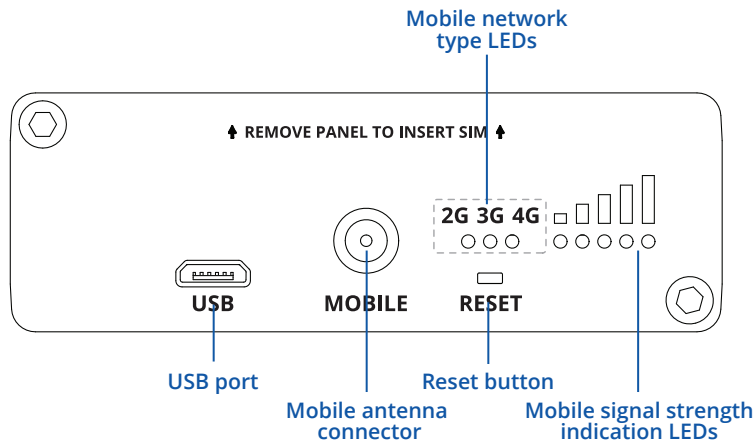

POWER SOCKET PINOUT

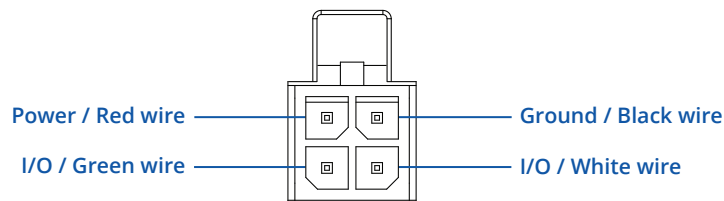

DB9 CONNECTOR PINOUT

1. Not used.
2. Received Data (RX) – output.
3. Transmitted data (TX) – input.
4. Not used.
5. Ground (GND).
6. Not used.
7. Request data to send (RTS) – input.
8. Clear data to send (CTS) – output.
9. Not used.

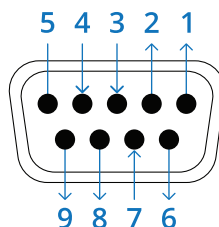

FEATURES

MOBILE

Mobile module	4G (LTE) – Cat 1 up to 10 Mbps, 3G – Up to 42 Mbps, 2G – Up to 236.8 kbps
Status	Signal strength (RSSI), SINR, RSRP, RSRQ, EC/IO, RSCP Bytes sent/received, connected band, IMSI, ICCID.
SMS/Call	SMS status, SMS configuration, send/read SMS via HTTP POST/GET, EMAIL to SMS, SMS to EMAIL, SMS to HTTP, SMS to SMS, scheduled SMS, SMS autoreply, Call utilities
USSD	Supports sending and reading Unstructured Supplementary Service Data messages
Black/White list	Operator black/white list
Band management	Band lock, Used band status display
APN	Auto APN
Bridge	Direct connection (bridge) between mobile ISP and device on LAN
Passthrough	Gateway assigns its mobile WAN IP address to another device on LAN
Multiple PDN	Possibility to use different PDNs for multiple network access and services

NETWORK

Routing	Static routing
Network protocols	TCP, UDP, IPv4, IPv6, ICMP, NTP, DNS, HTTP, HTTPS, SMTP, SSL v3, TLS, PPP, SSH, DHCP, SNMP, MQTT
Connection monitoring	Ping Reboot, Wget Reboot, Periodic Reboot, LCP and ICMP for link inspection
Firewall	Port forwards, traffic rules, custom rules
DHCP	Static and dynamic IP allocation
QoS / Smart Queue Management (SQM) (planned)	Traffic priority queuing by source/destination, service, protocol or port
DDNS	Supported >25 service providers, others can be configured manually
SSHFS	Possibility to mount remote file system via SSH protocol

SECURITY

Authentication	Pre-shared key, digital certificates, X.509 certificates
Firewall	Pre-configured firewall rules can be enabled via the WebUI, unlimited firewall configuration via CLI; NAT; NAT-T
Attack prevention	DDOS prevention (SYN flood protection, SSH attack prevention, HTTP/HTTPS attack prevention), port scan prevention (SYN-FIN, SYN-RST, X-mas, NULL flags, FIN scan attacks)
Mobile quota control	Set up custom data limits for SIM card
WEB filter	Blacklist for blocking out unwanted websites, Whitelist for specifying allowed sites only
Access control	Flexible access control of TCP, UDP, ICMP packets, MAC address filter

VPN

OpenVPN	Multiple clients and a server can run simultaneously, 12 encryption methods
OpenVPN Encryption	DES-CBC, RC2-CBC, DES-EDE-CBC, DES-EDE3-CBC, DESX-CBC, BF-CBC, RC2-40-CBC, CAST5-CBC, RC2-64-CBC, AES-128-CBC, AES-192-CBC, AES-256-CBC
IPsec	IKEv1, IKEv2, supports up to 5 x VPN IPsec tunnels (instances), with 5 encryption methods (DES, 3DES, AES128, AES192, AES256)
GRE	GRE tunnel
PPTP, L2TP	Client/Server services can run simultaneously, L2TPv3 support
ZeroTier	ZeroTier VPN
WireGuard	WireGuard VPN client and server support

SERIAL COMMUNICATION MODES

Modes	Console, OverIP, Modem (Full or Partial control), MODBUS RTU master, MODBUS gateway, NTRIP client (planned)
-------	---

MODBUS TCP SLAVE

ID filtering	Respond to one ID in range [1;255] or any
Allow remote access	Allow access through WAN
Custom registers	MODBUS TCP custom register block, which allows to read/write to a file inside the router, and can be used to extend MODBUS TCP slave functionality

MODBUS TCP MASTER

Supported functions	01, 02, 03, 04, 05, 06, 15, 16
Supported data formats	8 bit: INT, UINT; 16 bit: INT, UINT (MSB or LSB first); 32 bit: float, INT, UINT (ABCD (big-endian), DCBA (little-endian), CDAB, BADC), HEX, ASCII

MODBUS RTU MASTER

Supported baud rates	From 300 to 115200
Supported functions	01, 02, 03, 04, 05, 06, 15, 16
Supported data formats	8 bit: INT, UINT; 16 bit: INT, UINT (MSB or LSB first); 32 bit: float, INT, UINT (ABCD (big-endian), DCBA (little-endian), CDAB, BADC), HEX, ASCII
Number of data bits	From 5 to 8
Number of stop bits	1 or 2
Parity	None, Even, Odd
Flow control	None, RTS/CTS, Xon/Xoff

MQTT GATEWAY

Gateway	Allows sending commands and receiving data from MODBUS Master through MQTT broker
---------	---

DATA TO SERVER

Protocol	HTTP(S), MQTT, Azure MQTT, Kinesis
----------	------------------------------------

MONITORING & MANAGEMENT

WEB UI	HTTP/HTTPS, status, configuration, FW update, CLI, troubleshoot, system log, kernel log
FOTA	Firmware update from sever, automatic notification
SSH	SSH (v1, v2)
SMS	SMS status, SMS configuration, send/read SMS via HTTP POST/GET
Call	Reboot, Status, Mobile data on/off, Output on/off, answer/hang-up with a timer
TR-069	OpenACS, EasyCwmp, ACSLite, tGem, LibreACS, GenieACS, FreeACS, LibCWMP, Friendly tech, AVSystem
MQTT	MQTT Broker, MQTT publisher
JSON-RPC	Management API over HTTP/HTTPS
MODBUS	MODBUS TCP status/control
RMS	Teltonika Remote Management System (RMS)

IoT PLATFORMS

Cloud of Things	Allows monitoring of: Device data, Mobile data, Network info, Availability
ThingWorx	Allows monitoring of: WAN Type, WAN IP Mobile Operator Name, Mobile Signal Strength, Mobile Network Type
Cumulocity	Allows monitoring of: Device Model, Revision and Serial Number, Mobile Cell ID, ICCID, IMEI, Connection Type, Operator, Signal Strength, WAN Type and IP
Azure IoT Hub	Can send device IP, Number of bytes send/received/ 3G connection state, Network link state, IMEI, ICCID, Model, Manufacturer, Serial, Revision, IMSI, Sim State, PIN state, GSM signal, WCDMA RSCP WCDMA EC/IO, LTE RSRP, LTE SINR, LTE RSRQ, CELL ID, Operator, Operator number, Connection type, Temperature, PIN count to Azure IoT Hub server

SYSTEM CHARACTERISTICS

CPU	ARM Cortex-A7 1.2 GHz CPU
RAM	128 MB (50 MB available for userspace)
FLASH storage	512 MB (200 MB available for userspace)

FIRMWARE / CONFIGURATION

WEB UI	Update FW from file, check FW on server, configuration profiles, configuration backup
FOTA	Update FW/configuration from server
RMS	Update FW/configuration for multiple devices
Keep settings	Update FW without losing current configuration

FIRMWARE CUSTOMIZATION

Operating system	RutOS (OpenWrt based Linux OS)
Supported languages	Busybox shell, Lua, C, C++
Development tools	SDK package with build environment provided

INPUT/OUTPUT

Configurable I/O	2 x Configurable Inputs/Outputs. Digital input 0 - 5 V detected as logic low, 8 - 30 V detected as logic high. Open collector output, max output 30 V, 300 mA (not available in TRB142*2****)
Output control	HTTP POST/GET, Schedule
Events	SMS, EMAIL
I/O juggler	Allows to set certain I/O conditions to initiate event

POWER

Connector	4 pin industrial DC power socket
Input voltage range	9 – 30 VDC (4 pin industrial socket), reverse polarity protection, surge protection >33 VDC 10us max
Power consumption	< 5 W

PHYSICAL INTERFACES (PORTS, LEDS, ANNTENAS, BUTTONS, SIM)

RS232	1 x DB9 socket
I/Os	2 x Configurable I/O pins on 4 pin power connector (I/O not available in TRB142*2****)
USB	1 x Virtual network interface via micro USB
Status LEDs	3 x connection type status LEDs, 5 x connection strength LEDs, 1x Power LED
SIM	1 x SIM slot (Mini SIM – 2FF), 1.8 V/3 V
Power	1 x 4 pin power connector
Anntena	1 x SMA for LTE
Reset	Reboot/User default reset/Factory reset button

PHYSICAL SPECIFICATION

Casing material	Aluminum housing
Dimensions (W x H x D)	74.5 x 25 x 64.4 mm
Weight	135 g
Mounting options	Bottom and sideways DIN rail, Flat surface

OPERATING ENVIRONMENT

Operating temperature	-40 °C to 75 °C
Operating humidity	10 % to 90 % non-condensing
Ingress Protection Rating	IP30

REGULATORY & TYPE APPROVALS

Regulatory	CE/RED, EAC, RoHS, WEEE
------------	-------------------------

EMI

Standards	Draft ETSI EN 301 489-1 V2.2.0, Draft EN 301 489-19 V2.1.0, Draft ETSI EN 301 489-52 V1.1.0
ESD	EN 61000-4-2:2009
RS	EN 61000-4-3:2006 + A1:2008 + A2:2010
EFT	EN 61000-4-4:2012
Surge protection	EN 61000-4-5:2014
CS	EN 61000-4-6:2014
DIP	EN 61000-4-11:2004

RF

Standards	EN 300 511 V12.5.1, ETSI EN 301 908-1 V11.1.1, ETSI EN 301 908-2 V11.1.2, ETSI EN 301 908-13 V11.1.2
-----------	--

SAFETY

Standards	IEC 62368-1:2014(Second Edition), EN 62368-1:2014+A11:2017 EN 50385:2017 EN 62232:2017
-----------	--

HARDWARE INSTALLATION

1. Unscrew two back panel hex bolts and remove the back panel.
2. Insert your SIM card into the SIM socket.
3. Attach the panel and tighten the hex bolts.
4. Attach the mobile antenna (max torque 0.4 N·m / 3.5 lbf·in) and connect the USB cable.

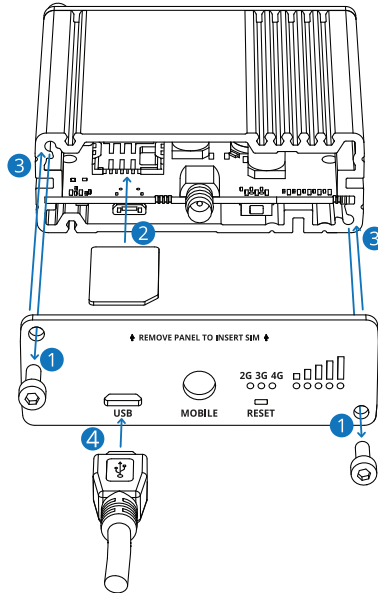

LOGIN TO DEVICE

1. Power on the device and connect the USB cable to your computer.
2. Allow the gateway to boot up. This might take up to 30 seconds.
3. Your computer's OS should detect the USB device and install the driver.
4. To enter the gateway's Web interface (WebUI), type <http://192.168.2.1> into the URL field of your Internet browser.
5. Use login information shown in image A when prompted for authentication.
6. After logging in pay attention to the Signal Strength indication displayed in the Mobile widget (image B). To maximize the cellular performance try adjusting the antennas or changing the location of your device to achieve the best signal conditions.

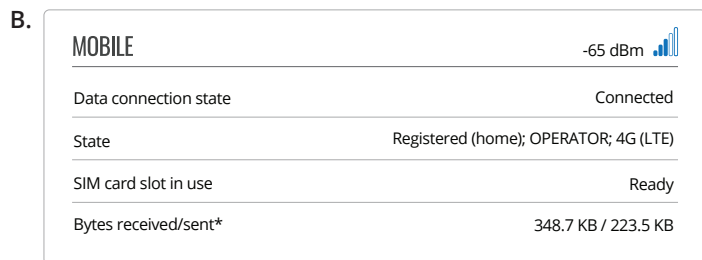
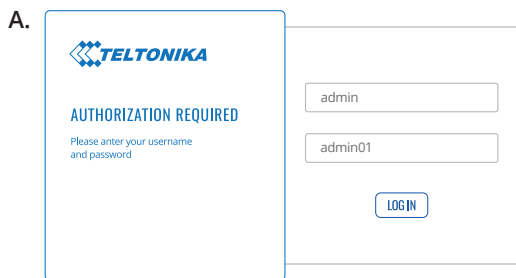

TECHNICAL INFORMATION

Radio specifications	
RF technologies	2G, 3G, 4G
Max RF power	33 dBm@GSM, 24 dBm@WCDMA, 23 dBm@LTE
Bundled accessories specifications*	
Power adapter	Input: 0.4A@100-240VAC, Output: 9VDC, 0.5A, 4-pin plug
Mobile antenna	698~960/1710~2690 MHz, 50 Ω, VSWR<2, gain** 2 dBi, omnidirectional, SMA male connector

*Order code dependent.

**Higher gain antenna can be connected to compensate for cable attenuation when a cable is used. The user is responsible for the compliance with the legal regulations.

WHAT'S IN THE BOX?

STANDARD PACKAGE CONTAINS*

- TRB142
- 4.5 W PSU
- 1 x LTE antenna (magnetic mount, SMA male, 3 m cable)
- Micro-USB cable (0.8 m)
- 1 x hex key
- QSG (Quick Start Guide)
- RMS flyer
- Packaging box



 <p>TRB142</p>	 <p>4.5 W PSU</p>	 <p>1 X LTE ANTENNA (MAGNETIC MOUNT, SMA MALE, 3 M CABLE)</p>
 <p>MICRO-USB CABLE (0.8 M)</p>	 <p>1 X HEX KEY</p>	

* For all standard order codes standard package contents are the same, except for PSU.

STANDARD ORDER CODES

PRODUCT CODE	HS CODE	HTS CODE	PACKAGE CONTAINS
TRB1420 03000	851762	8517.62.00	Standard Package

For more information on all available packaging options – please contact us directly.

AVAILABLE VERSIONS

PRODUCT CODE	REGION (OPERATOR)	FREQUENCY
TRB142 0*****	Europe, the Middle East, Africa, Korea, Thailand, India, Malaysia	<ul style="list-style-type: none"> ● 4G (LTE-FDD): B1, B3, B7, B8, B20, B28A ● 3G: B1, B8 ● 2G: B3, B8
TRB142 1*****	South America, Australia, New Zealand, Taiwan	<ul style="list-style-type: none"> ● 4G (LTE-FDD): B1, B2, B3, B4, B5, B7, B8, B28 ● 4G (LTE-TDD): B40 ● 3G: B1, B2, B5, B8 ● 2G: B2, B3, B5, B8
TRB142 2*****	China	<ul style="list-style-type: none"> ● 4G (LTE-FDD): B1, B3 ● 4G (LTE-TDD): B38, B39, B40, B41 ● 3G (TDSCDMA): B34, B39 ● 3G (WCDMA): B1 ● 3G (CDMA 1x/EVDO): BC0 ● 2G: B3, B8

The price and lead-times for region (operator) specific versions may vary. For more information please contact us.
 * - Versions for other regions are under development.

MOUNTING OPTIONS

DIN RAIL KIT

Parameter	Value
Mounting standard	35mm DIN Rail
Material	Low carbon steel
Weight	57g
Screws included	Philips Pan Head screw #6-32×3/16, 2pcs
Dimensions	82 mm x 46 mm x 20 mm
RoHS Compliant	V

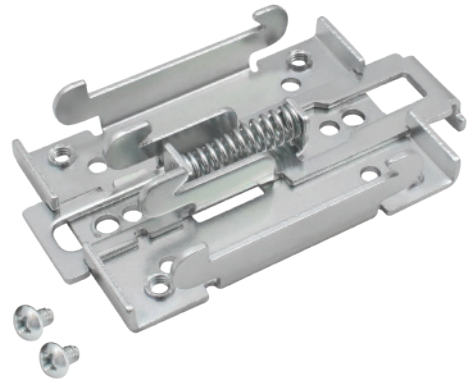

DIN RAIL KIT

- DIN Rail adapter
- Philips Pan Head screw #6-32×3/16, 2pcs for RUT2xx/RUT9xx

ORDER CODE

PR5MEC00

HS CODE

73269098

HTS CODE

7326.90.98

For more information on all available packaging options – please contact us directly.

COMPACT DIN RAIL KIT

Parameter	Value
Mounting standard	35mm DIN Rail
Material	ABS + PC plastic
Weight	6.5 g
Screws included	Philips Pan Head screw #6-32×3/16, 2pcs
Dimensions	70 mm x 25 mm x 14,5 mm
RoHS Compliant	V



DIN RAIL KIT

- Compact plastic DIN Rail adapter (70x25x14,5mm)
- Philips Pan Head screw #6-32×3/16, 2pcs

ORDER CODE

PR5MEC11

HS CODE

73269098

HTS CODE

7326.90.98

For more information on all available packaging options – please contact us directly.

SURFACE MOUNTING KIT

Parameter	Value
Mounting standard	Flat surface mount
Material	ABS + PC plastic
Weight	2x5 g
Screws included	Philips Pan Head screw #6-32×3/16, 2pcs
Dimensions	25 mm x 48 mm x 7.5 mm
RoHS Compliant	V



DIN RAIL KIT

- Surface mounting kit
- Philips Pan Head screw #6-32×3/16, 2pcs

ORDER CODE

PR5MEC12

HS CODE

73269098

HTS CODE

7326.90.98

For more information on all available packaging options – please contact us directly.

TRB142 SPATIAL MEASUREMENTS & WEIGHT

MAIN MEASUREMENTS

W x H x D dimensions for TRB142

Device housing*:	74.5 x 25 x 64.4
Box:	173 x 71 x 148

*Housing measurements are presented without antenna connectors and screws; for measurements of other device elements look to the sections below.

TOP VIEW

The figure below depicts the measurements of TRB142 and its components as seen from the top:

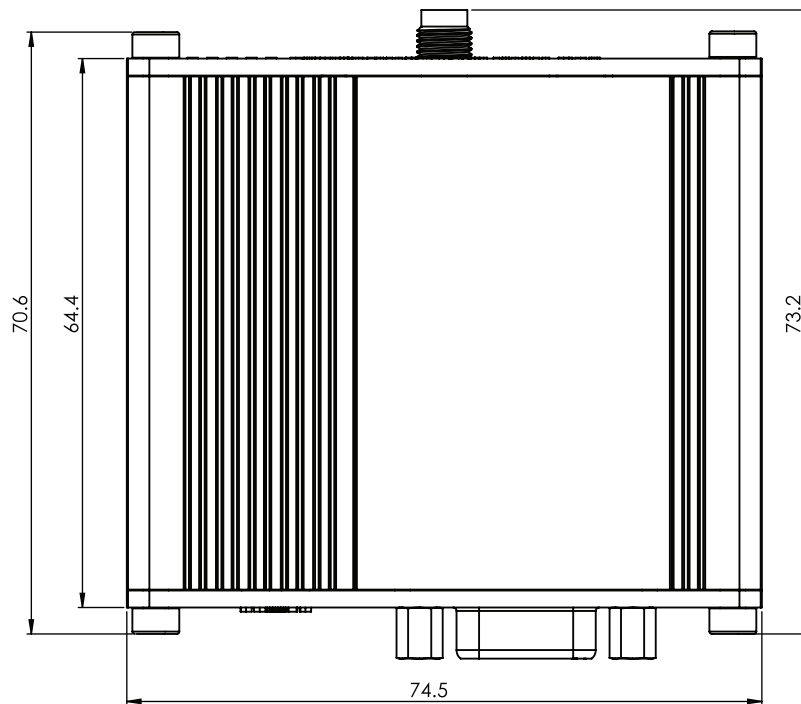

RIGHT VIEW

The figure below depicts the measurements of TRB142 and its components as seen from the right side:

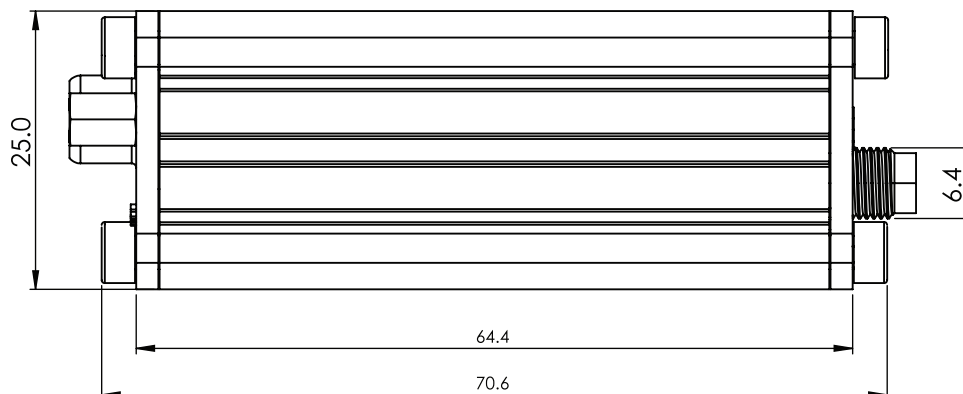

FRONT VIEW

The figure below depicts the measurements of TRB142 and its components as seen from the front:

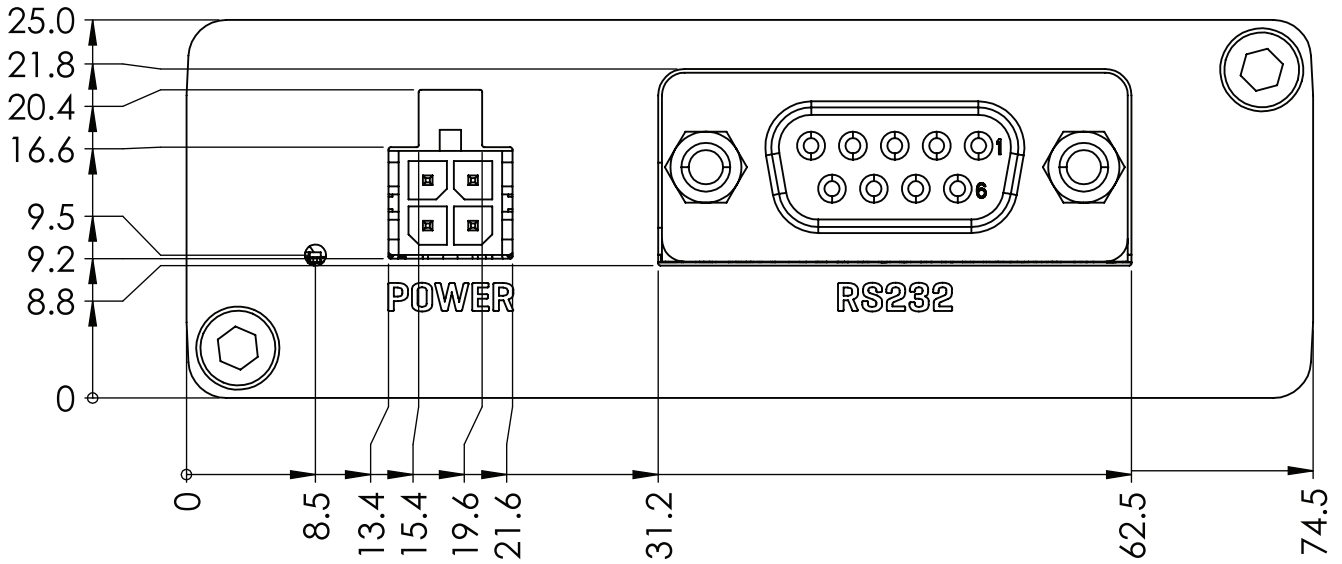

REAR VIEW

The figure below depicts the measurements of TRB142 and its components as seen from the back:

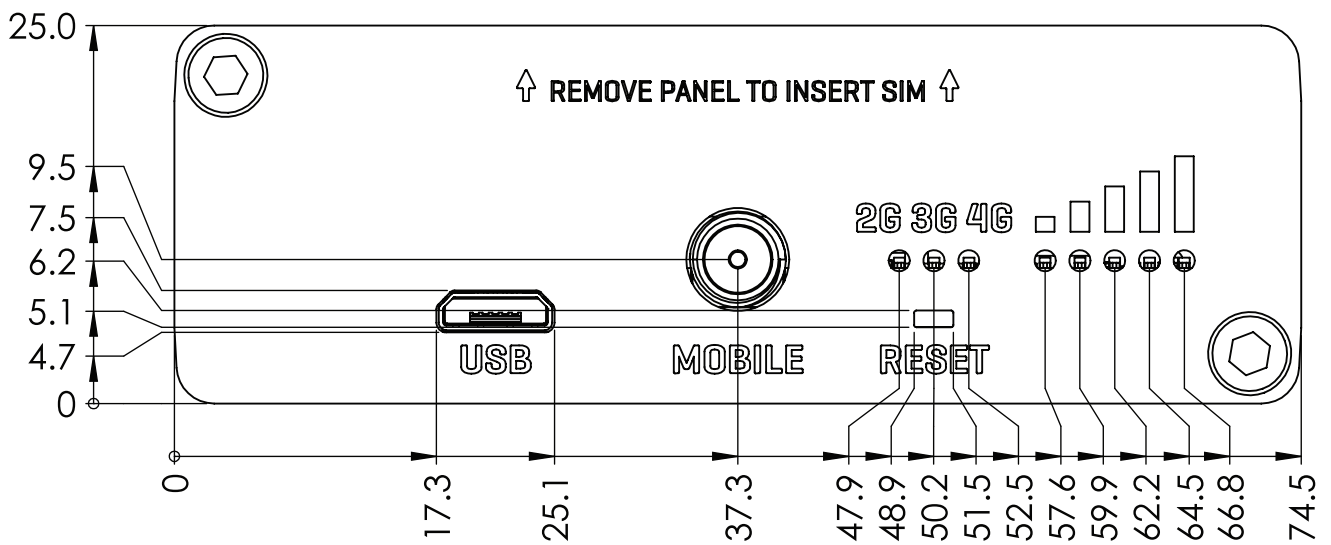

MOUNTING SPACE REQUIREMENTS

The figure below depicts an approximation of the device's dimensions when cables and antennas are attached:

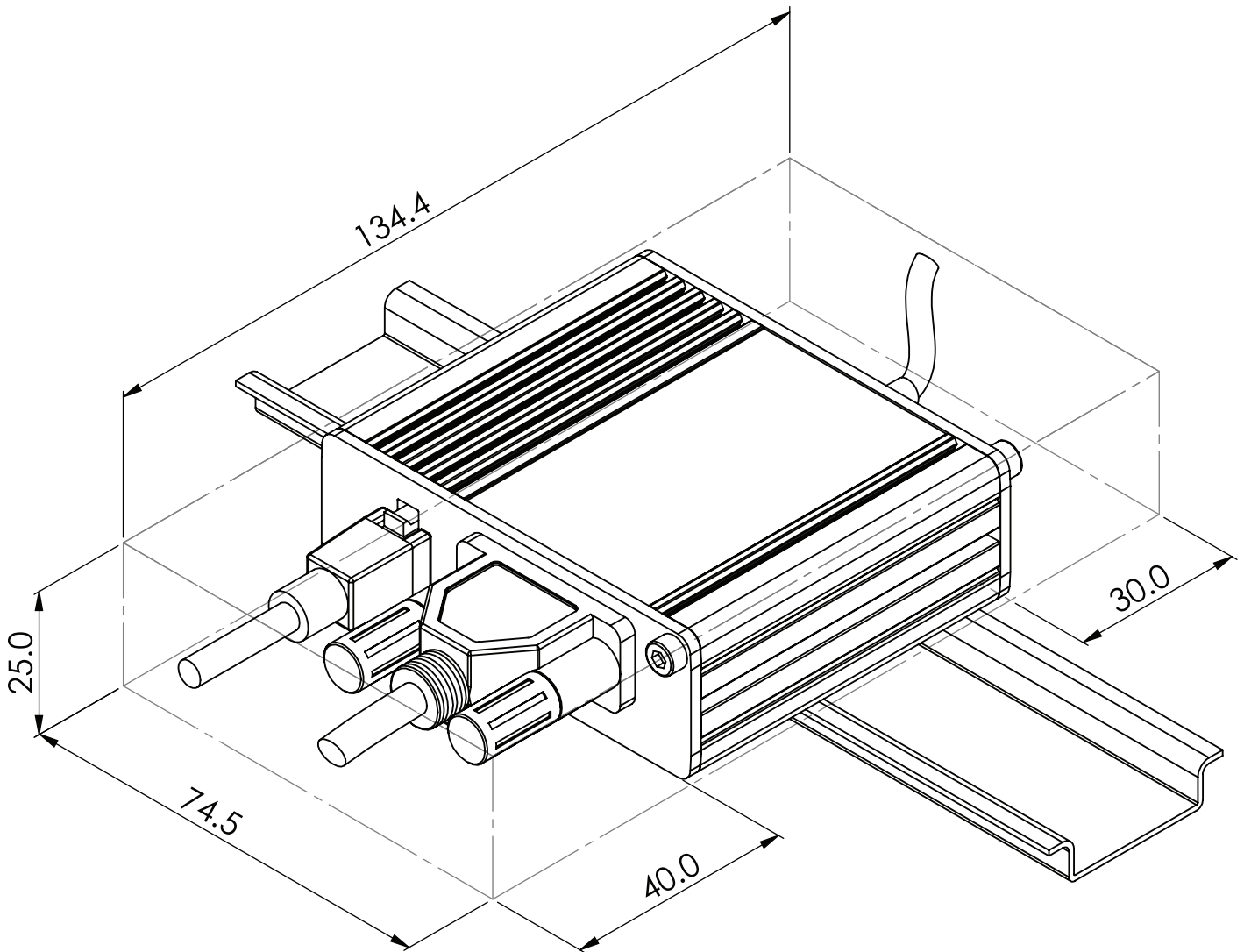

DIN RAIL

The scheme below depicts protrusion measurements of an attached DIN Rail:

