



# TSW212



# HARDWARE

## FRONT VIEW

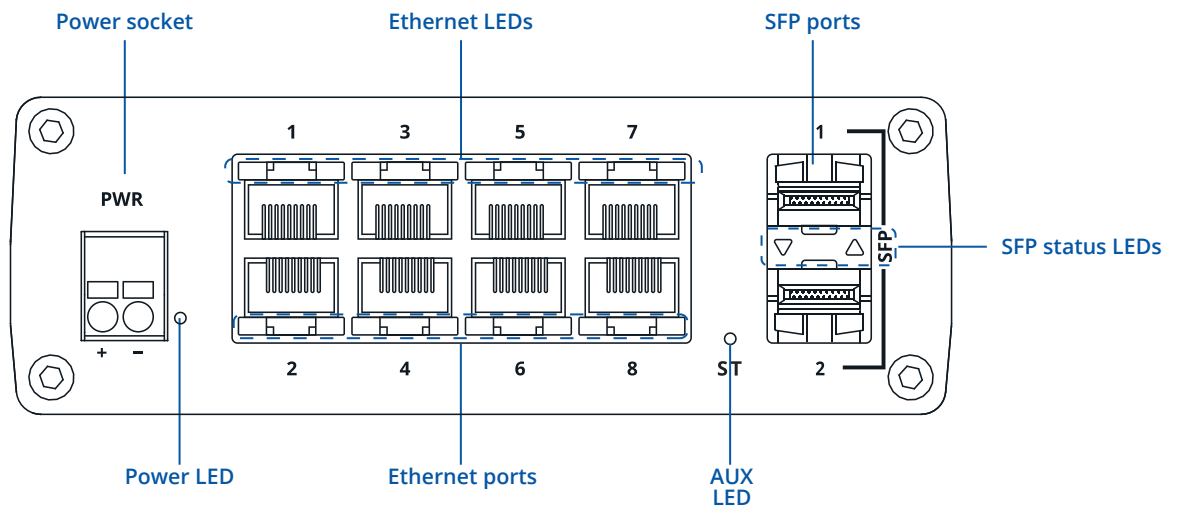

## BACK VIEW

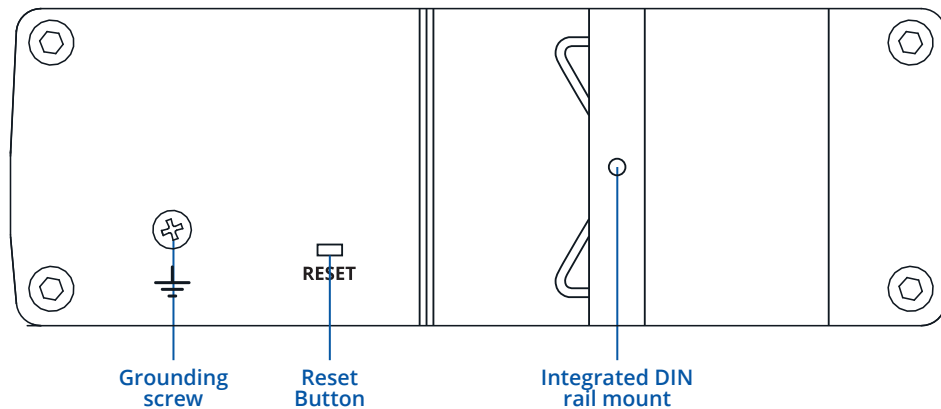

## RJ45 LED MEANING

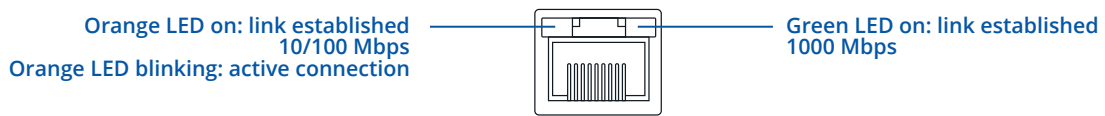

## POWER SOCKET PINOUT

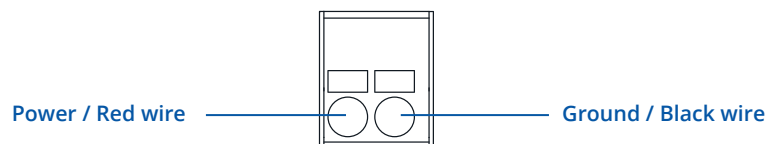

## SFP LED MEANING

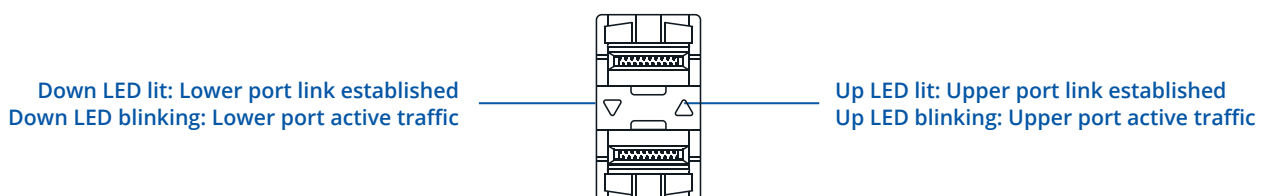

## FEATURES

### ETHERNET

LAN	Multi-layer managed 8 x LAN ports, 10/100/1000 Mbps supports auto MDI/MDIX crossover
Fibre	2 x SFP ports
IEEE 802.3 series standards	IEEE 802.1p, IEEE 802.1Q, 802.3az

### SERVICES

EtherNet/IP	Yes
Profinet (class B)	Yes
SNMP V2, V3	Yes
LLDP	Yes

### NETWORK

MRP	MRP client role, MRP manager role
L2 features	Loop protection, Forwarding table, VLAN, STP/RSTP
DHCP	DHCP server, DHCP client
Port Settings	Enable/disable, link speed control, port isolation, EEE (802.3az) management, Port Mirroring
L3 Features	Static IPv4 routing, static IPv6 routing, DHCPv6 client, static IPv6 address

### QOS

QOS	Port priority, DSCP priority, 802.1p priority, TOS
Scheduling method	SP/WFQ/WRR
Bandwidth control	Rate limiting, storm control

### DIAGNOSTICS

Tools	Cable diagnostic, ping, traceroute, nslookup
-------	--

### PERFORMANCE SPECIFICATIONS

Bandwidth (Non-blocking)	20 Gbps
Packet buffer	512 KB
MAC address table size	8K entries
Jumbo frame support	10000 bytes

### SYSTEM CHARACTERISTICS

RAM	128MB, DDR3
FLASH storage	16MB serial flash

### FIRMWARE / CONFIGURATION

WEB UI	Update FW from file, check FW on server, configuration profiles, configuration backup
FOTA	Update FW
RMS	Update FW, configuration for multiple devices at once
Keep settings	Update FW without losing current configuration

### FIRMWARE CUSTOMISATION

Operating system	TSWOS (OpenWrt based Linux OS)
Supported languages	Busybox shell, Lua, C, C++, and Python, Java in Package manager
Development tools	SDK package with build environment provided

**POWER**

Connector	2-pin industrial DC power socket
Input voltage range	7 - 57 VDC
Power consumption	Idle: < 2.5 W / Max: 6 W

**PHYSICAL INTERFACES**

Ethernet	8 x RJ45 ports, 10/100/1000 Mbps
Fibre	2 x SFP ports
Status LEDs	1 x Power LED, 1 x Aux LED, 16 x LAN status LEDs, 2 x SFP status LEDs
Power	1 x 2-pin industrial DC power socket
Reset	Software reset button
Grounding	Grounding screw

**PHYSICAL SPECIFICATION**

Casing material	Anodized aluminum housing and panels
Dimensions (W x H x D)	132 x 44.2 x 122 mm
Weight	615 g
Mounting options	Integrated DIN rail bracket, wall mounting (additional kit needed), flat surface placement

**OPERATING ENVIRONMENT**

Operating temperature	-40 °C to 75 °C
Operating humidity	10 % to 90 % non-condensing
Ingress Protection Rating	IP30

**REGULATORY & TYPE APPROVALS**

Regulatory	CE, CB, RCM, FCC, IC,EAC, UCRF
------------	--------------------------------

**EMC EMISSIONS & IMMUNITY**

Standards	EN 55032:2015+A1:2020; EN 55035:2017+A11:2020; EN IEC 61000-6-2:2019
ESD	EN 61000-4-2:2009
Radiated Immunity	EN IEC 61000-4-3:2020
EFT	EN 61000-4-4:2012
Surge Immunity (AC Mains Power Port)	EN 61000-4-5:2014+A1:2017
CS	EN 61000-4-6:2014
DIP	EN IEC 61000-4-11:2020

**SAFETY**

Standards	IEC 62368-1:2018
-----------	------------------

## WHAT'S IN THE BOX?

### STANDARD PACKAGE CONTAINS

- TSW212
- QSG (Quick Start Guide)
- Packaging box



## STANDARD ORDER CODES

PRODUCT CODE	HS CODE	HTS CODE	PACKAGE CONTAINS
TSW212 000000	851762	8517.62.00	Standard package

For more information on all available packaging options – please contact us directly.

## TSW212 SPATIAL MEASUREMENTS & WEIGHT

### MAIN MEASUREMENTS

W x H x D dimensions for TSW212:

Device housing\*: 132 x 44.2 x 122 mm

Box: 173 x 71 x 148 mm

\*Housing measurements are presented without antenna connectors and screws; for measurements of other device elements look to the sections below.

### TOP VIEW

The figure below depicts the measurements of TSW212 and its components as seen from the top:

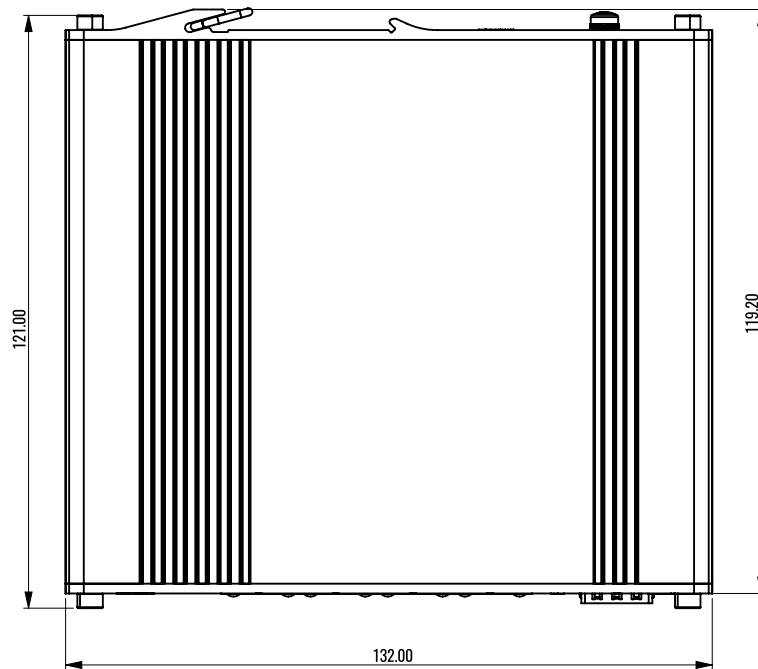

### RIGHT VIEW

The figure below depicts the measurements of TSW212 and its components as seen from the right side:

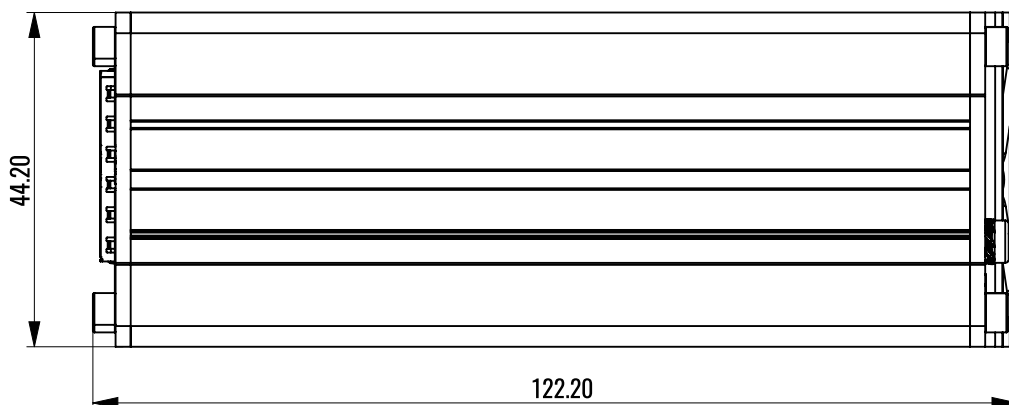

**FRONT VIEW**

The figure below depicts the measurements of TSW212 and its components as seen from the front panel side:

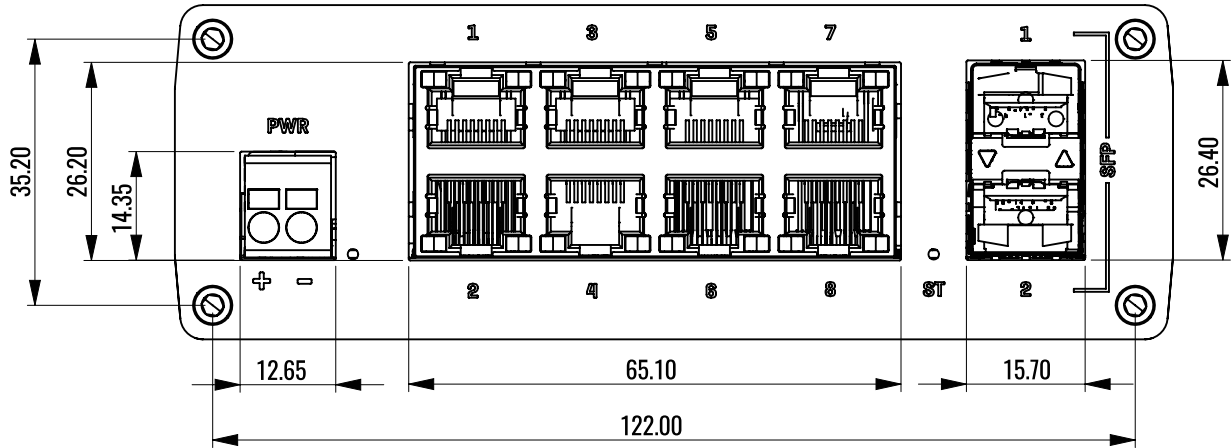

**REAR VIEW**

The figure below depicts the measurements of TSW212 and its components as seen from the back panel side:

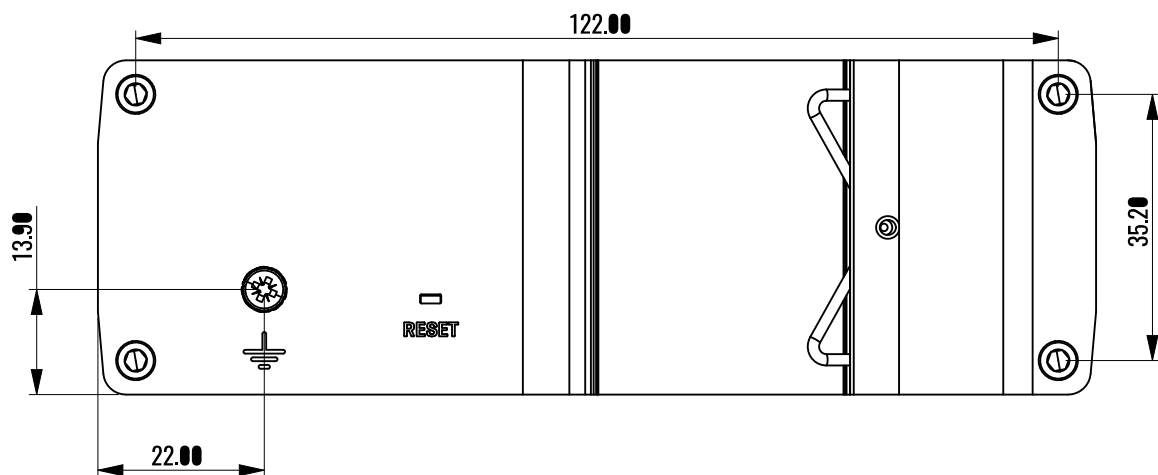

**MOUNTING SPACE REQUIREMENTS**

The figure below depicts an approximation of the device's dimensions when cables and antennas are attached:

